



E-mail: distributor@hyggeraquarium.com

Website: www.hyggeraquarium.com



HG125 hygger high flow low noise air pump user manual

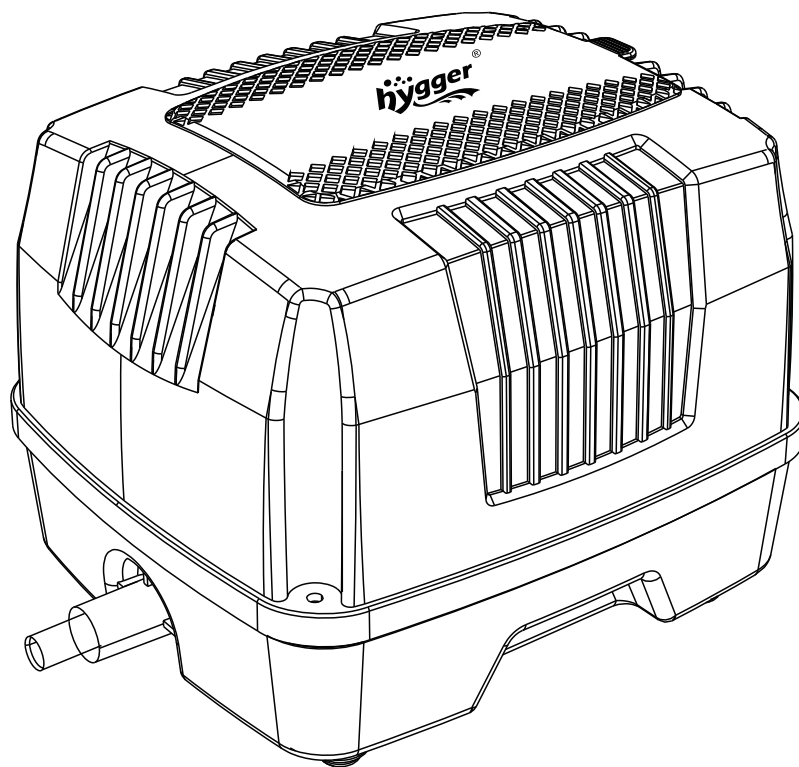

Please read this manual carefully before use and follow all instructions.

1. PRODUCT FEATURES

- **Energy Saving:** This innovative pump significantly reduces energy consumption and optimizes efficiency without sacrificing performance.
- **Super Powerful:** Equipped with a robust motor, this pump provides sufficient airflow for various applications.
- **Ultra-quiet operation:** The noise development during operation is significantly reduced so that the pump noise is not disturbing in daily operation.
- **Stable performance:** Its design ensures stable performance and reliability under various conditions.

2. PACKING LIST

Model	HG125-30	HG125-50	HG125-80	HG125-160
Air Pump	1	1	1	1
Divert Valve with Outlets	6 in 1	8 in1	17 in1	46 in1
Rubber Conversion Connector	1	1	1	1
Metal Hose Clip(Small)	1	1	1	1
Metal Hose Clamp(Big)	×	×	×	√
Copper Nozzle	×	×	√	√
User Manual	√			

3. PRODUCT SPECIFICATIONS

Model	HG125-30	HG125-50	HG125-80	HG125-160
Volt/Freq	US standard: AC 110-120V/60Hz EU/UK/AU standard: AC220-240V/50Hz			
Power	18W	25W	40W	105W
Air Pressure	0.030Mpa	0.030Mpa	0.030Mpa	0.042Mpa
Air Volume	30L/Min (475GPH)	50L/Min (800GPH)	80L/Min (1270GPH)	160L/Min (2550GPH)
Nozzle Diameter	17.5mm (0.69 in)	17.5mm (0.69 in)	21mm (0.83 in)	21mm (0.83 in)
Product Size	200x160x175 mm (7.87x6.30x6.89 in)	200x160x175 mm (7.87x6.30x6.89 in)	250x200x195 mm (9.84x7.87x7.68 in)	275x220x205 mm (10.83x8.66x8.07 in)

4. INSTRUCTIONS

A.The following are two ways to install the air pump:

Picture 1: If the air pump is placed below the level of the water surface in the tank, you **MUST** install the air pump with check valves. If you do not use a check valve, the water will drain back to the pump, resulting in damage to it.

Picture 2: Place the air pump 25 cm (approximately 9.8inches) higher than the water surface in the tank to avoid water back flow

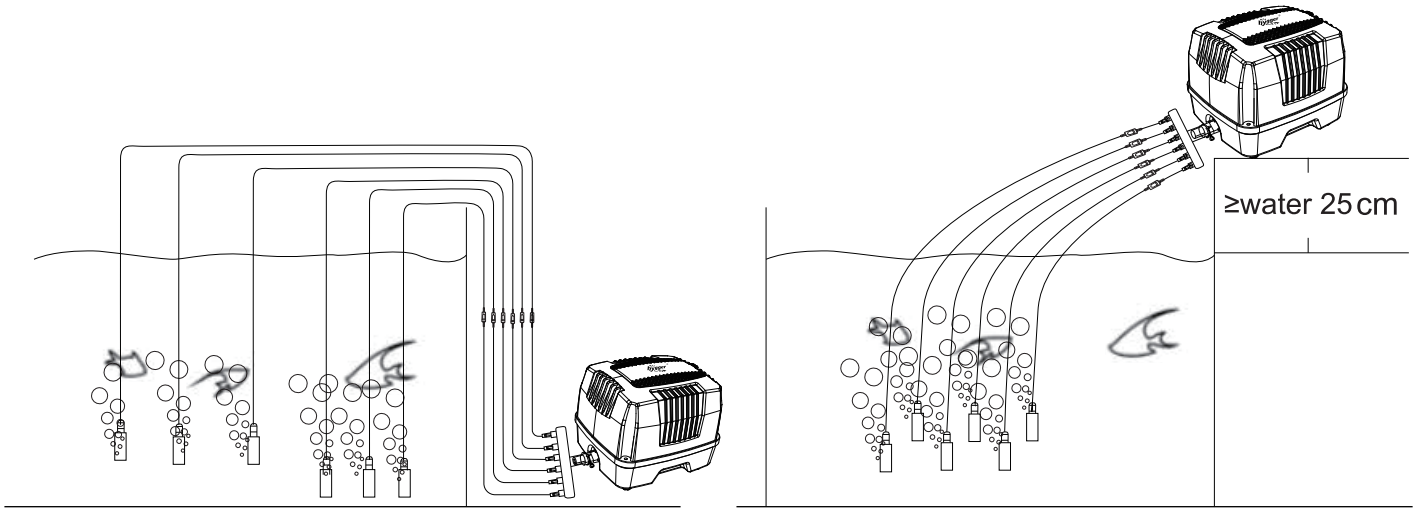

Picture 1

Picture 2

B. Install the air pump with accessories

(Please Note: Check valve, air stone and air tube must be purchased separately)

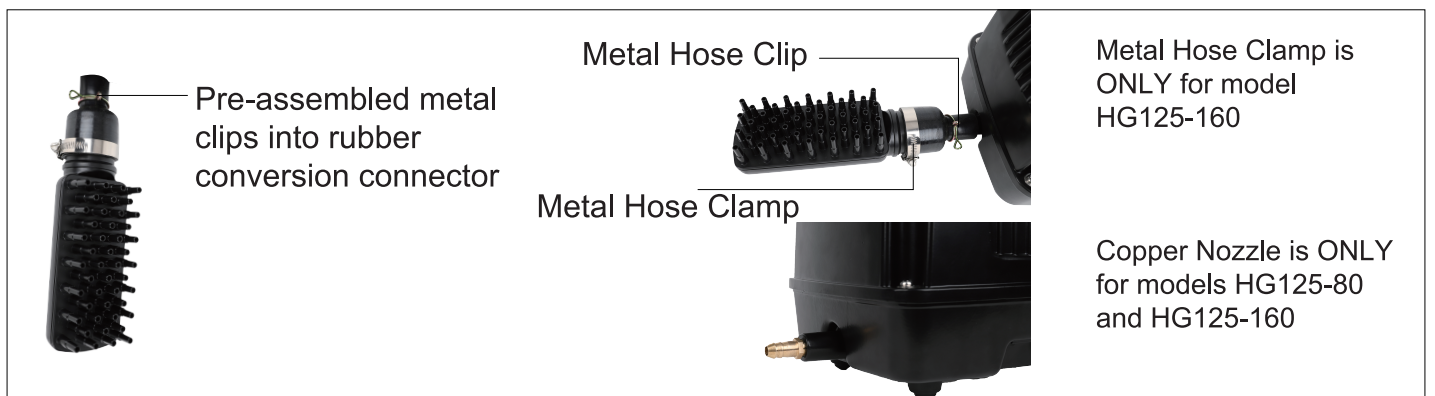
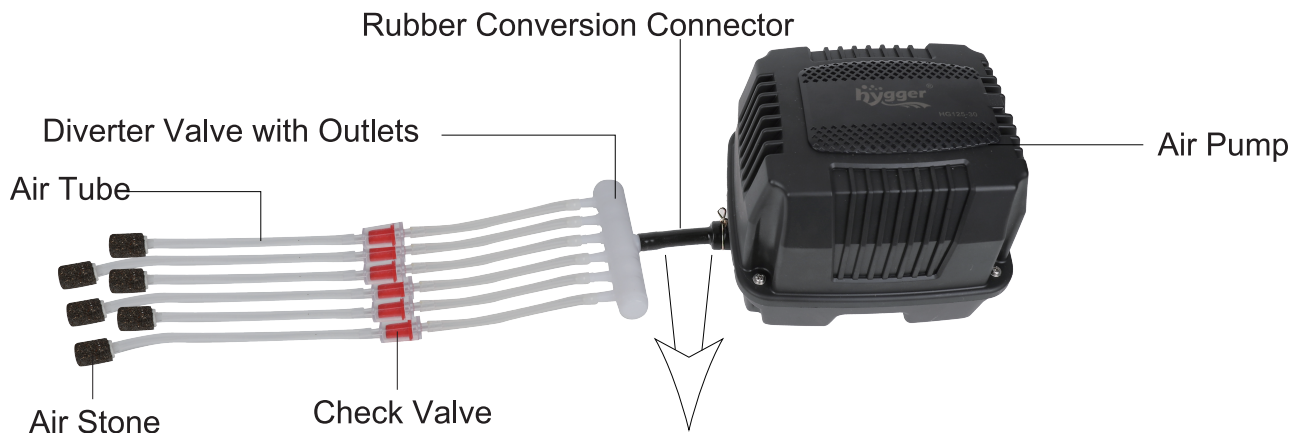

C. Usage Scenarios

- Scene 1: Aquaculture

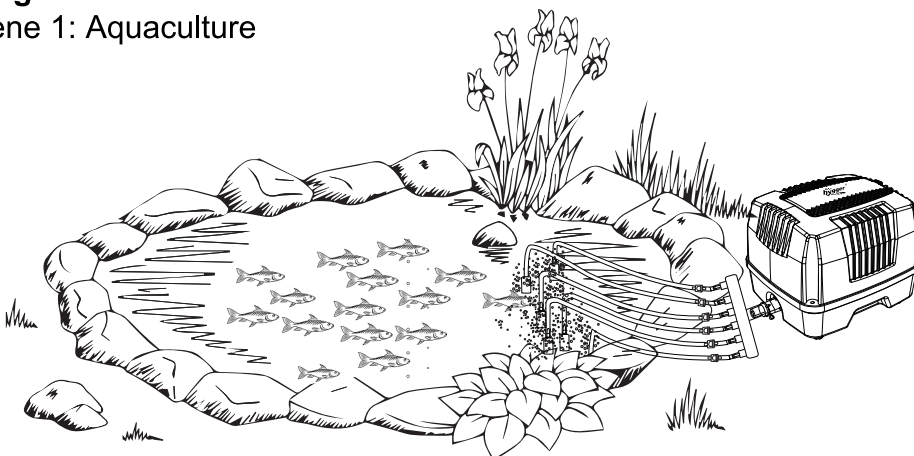

- Scene 2: Commercial Breeding

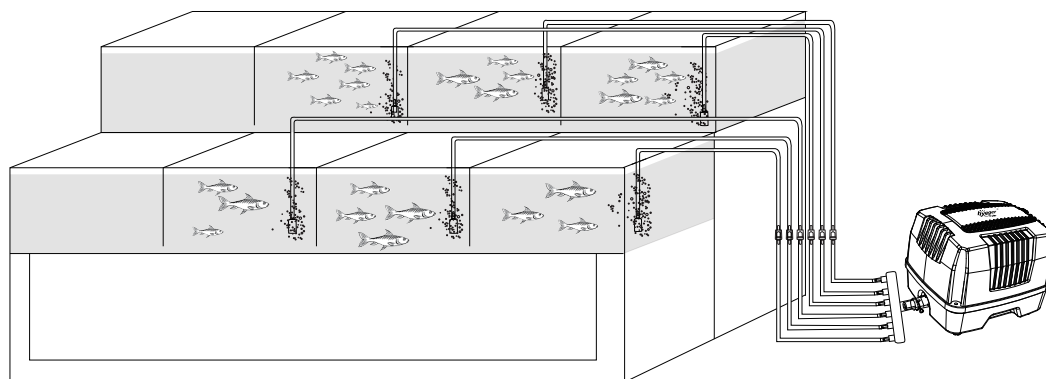

- Scene 3: Septic Aeration

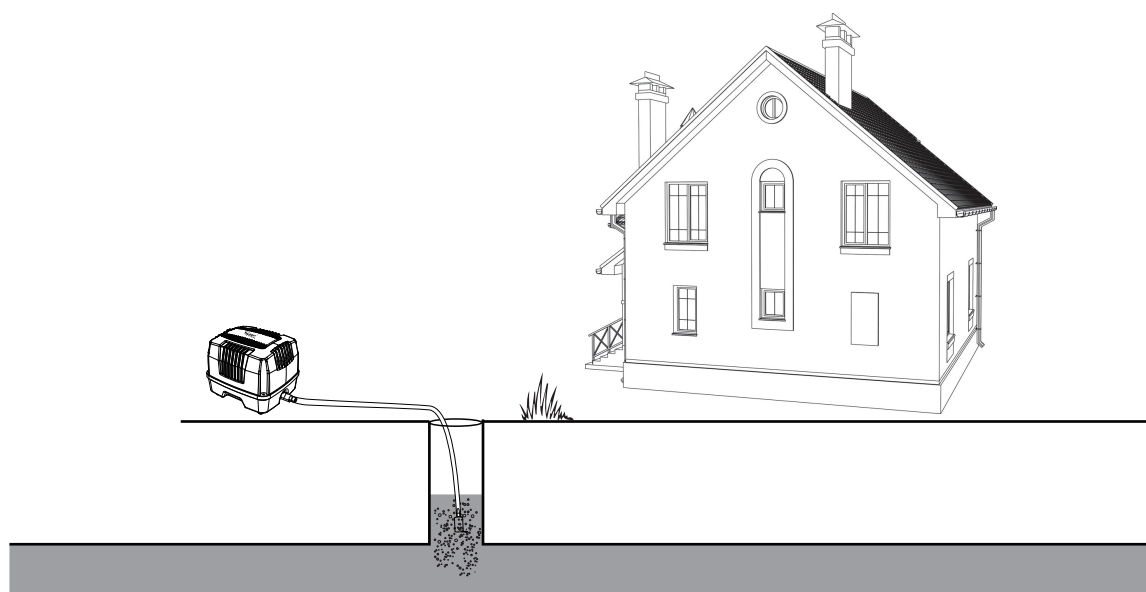

5. ATTENTIONS

- Please read and follow this user manual carefully before using it.
- Please install the air pump with check valves or place the air pump 25cm (10 inches) higher than the water surface to avoid water backflow and potential damage to the pump.
- Place the air pump on a flat surface and put a towel or rubber mat under the pump to reduce the noise further.
- Please keep the air pump away from water since it is not waterproof.
- Please keep the air pump away from flammable items to avoid accidents.
- Please unplug the power and contact the seller if the air pump is making abnormal sounds, overheating, or has no air output.

PERSONAL DISASSEMBLY WILL VOID THE WARRANTY

- Please note that airflow loss is usually caused by a clogged air-stone, which is the result of algae, floating debris, and mineral deposits accumulated in the pores. If you notice a diminished airflow, try blowing through the air-stone by yourself. If it is difficult, replace the air-stone.
- Please unplug the power before maintenance.

- Please notice that the operating temperature range for the air pump is between 32°F-100°F (0°C-38°C).

6. TROUBLESHOOTING

Trouble	Explanation	Solutions
Unusual noise	Unusual noise or vibration is usually caused by an uneven surface or faulty connection	Ensure the air pump is placed on a level surface and check all connections
No air or low air	The air stone is placed too deep in the water	Place the air stone less deeply into the water
	Deterioration of the diaphragm inside the air pump	Contact the supplier for new diaphragms
The air pump doesn't run	Failed to connect to the power supply	Plug the cord into an outlet
	Lack of voltage	Check the wire and voltage

7. WARNING

To avoid possible electric shock, do not immerse the pump in the water. If the pump falls into the water or becomes wet, do not touch it until you have unplugged it. Basic safety precautions that should be observed are as follows:

CAUTION: To avoid the risk of electric shock due to water backflow, the pump should be used with a check valve or positioned higher than the water level in the tank.

1. Read and follow this user manual strictly.

2. **DANGER** - To avoid the possibility of electric shock, special care should be taken when using aquarium equipment since water is involved. In any of the following situations, do not attempt to repair yourself. Instead, return the pump to an authorized service facility for maintenance or discard it.

A. If the pump falls into the water, do not touch it. First unplug it, then pull it out. If electrical parts of the pump get wet, unplug the pump immediately.

B. Check the pump carefully after installation. It should not be connected if there is water on parts that are not intended to be wet.

C. Do not operate the pump if it has a damaged cord or plug, is faulty, has been dropped or damaged in any way. The power cord for this pump is not replaceable. If the cord is damaged, the pump should be discarded.

D. To avoid the possibility of the pump plug getting wet, position the aquarium and stand to one side of a wall mounted socket to prevent water dripping onto the socket or plug. A "drip loop", as shown in the diagram below, should be provided by the user for each cord connecting the pump to the socket. If an extension cord is used, the "drip loop" is the part of the cord below the level of the outlet or plug that prevents water from travelling along the cord and coming into contact with the outlet. If the plug or socket does get wet, **DO NOT** unplug the cord. Remove the fuse from the circuit breaker that supplies power to the pump. Then unplug the power cord and check for water in the outlet. If in doubt, consult a qualified electrician.

POWER CORD



DRIP LOOP

3. Close supervision is required when the pump is used near children.

4. To avoid injury, do not contact moving or hot parts.

5. Always unplug the pump when it is not in use, before assembling or disassembling parts, before carrying out maintenance or before putting your hands in the water. Never pull on the cord to unplug. Grasp the plug and pull to disconnect.

6. Do not use the pump for any purpose other than its intended use. The use of attachments not recommended or sold by the manufacturer of the equipment can lead to an unsafe condition and will void the warranty.

7. Do not install or store the pump where it will be exposed to extreme weather or temperatures below freezing. This pump is suitable for use in temperatures between 32~100 °F.

8. Make sure the pump is securely installed before operating it.

9. Read and observe all the important notices on the pump.

10. If an extension cord is required, use a cord with the correct rating, such as amperes or watts. A cord rated for less amps or watts than the pump rating may overheat. Care should be taken to arrange the cord so that it cannot be tripped over or pulled.

11. The pump is intended FOR HOUSEHOLD USE ONLY.

12. SAVE THIS USER MANUAL.

8. ONE YEAR LIMITED WARRANTY

This product MUST be purchased from an authorized hygger reseller. Visit our website for a list of authorized resellers. hygger warrants this product against defects in materials and workmanship for ONE(1) YEAR from the date of the original retail purchase and is none-transferable. Warranty on all products, including aquariums. But it is limited to the replacement of the products and does not cover fish loss, personal injury, property loss or direct, incidental or consequential damage caused by using this product.

Note: hygger One-year Limited Warranty does not cover damage caused by the followings: improper installation, saltwater corrosion, electrical surges or modifications. Additionally, products that have been refunded are also not covered under the warranty.

If you discover a defect, please contact hygger, who will, at its option, repair or replace the product at no charge, provided that you return it during the warranty period. A copy of the bill of sale is required as a proof of the original purchase date in the event of the product needing repairs within the warranty period. hygger does not warrant any products that aren't hygger's.

This warranty does not apply if the product has been damaged by accident, abuse, misuse or misapplication, or modified without the written permission of hygger.

9. DISPOSAL

Do not dispose of this product as unsorted municipal waste. Such waste must be collected separately for special treatment. This product must be disposed of at an authorized site for the recycling of electrical and electronic equipment, and not together with household waste. Collecting and recycling waste is a way of conserving natural resources. Please contact your local retailer to ensure that this product is disposed of in an environmentally friendly way.

10. CONTACT INFORMATION

Distributed by: Hygger Aquarium, Inc.
13941 Magnolia Ave, Chino, CA 91710

E-mail: distributor@hyggeraquarium.com

Website: www.hyggeraquarium.com

Trademarks of Shenzhen Mago Trading Co., Ltd
Bantian Group Business Center, Longgang,
Shenzhen City, China
All Rights Reserved

Made in China